



FLOATING SOLAR PV
GLOBAL DEVELOPMENT
THROUGH 2017

Lilita Pacudan
Project & Capacity Devt. Specialist / Consultant
CWEN, ADB



Overview

- **Technology concepts**
- **Trends in FPV installations**
- **Way forward**

Solar PV Installations

- ground-mounted
- rooftop
- canal-top
- floating
 - In-land
 - Off-shore



Floating Solar PV Technology



Solar power generation + Floating system

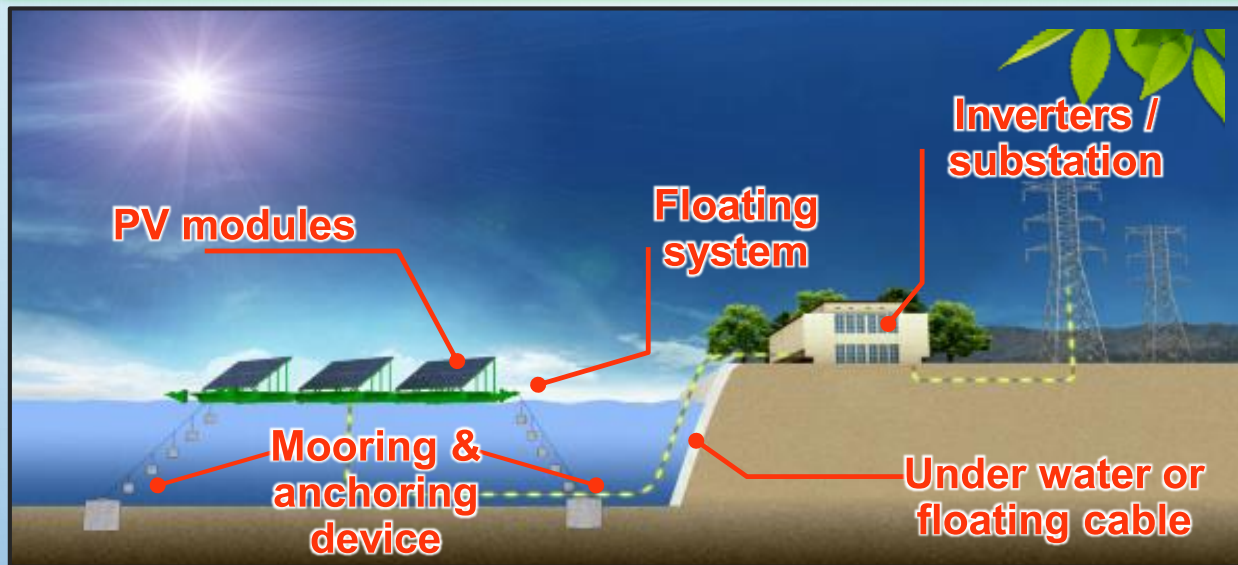

Core technology

- ✓ Suitable PV modules for water environment
- ✓ Mooring device to adapt the change of water levels
- ✓ Stable floating system
- ✓ Under water or floating cable connection to the local power grid

Floating Solar PV Technology

→ Design considerations

❑ ***PV modules***

- follow more stringent requirements compared to land-based PV modules due to exposure to water environment
 - Corrosion, possible short circuiting, etc.

❑ ***Floating platform***

- floats are typically made of HDPE (high density poly-ethylene), known for its tensile strength, UV and corrosion resistance

Floating Solar PV Technology

→ Design considerations

❑ Floating platform

- Sample commercially-available technologies:

Sumitomo Mitsui



Takiron Engineering

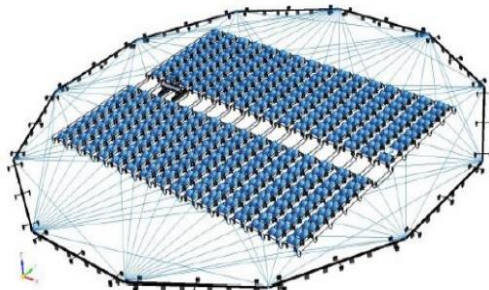

Solaris Synergy System



Koine Multimedia

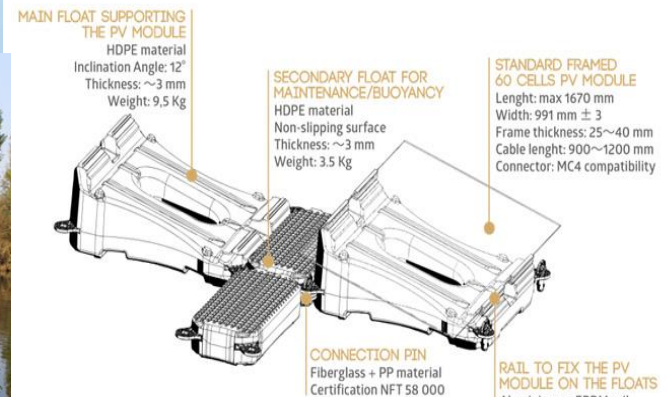

Ciel et Terre Hydrelio system

Floating Solar PV Technology



design considerations

- ❑ **Anchoring and mooring system**
 - **Anchoring at the banks** - most cost-effective anchoring system
 - **Anchoring at the bottom** - most widely installed

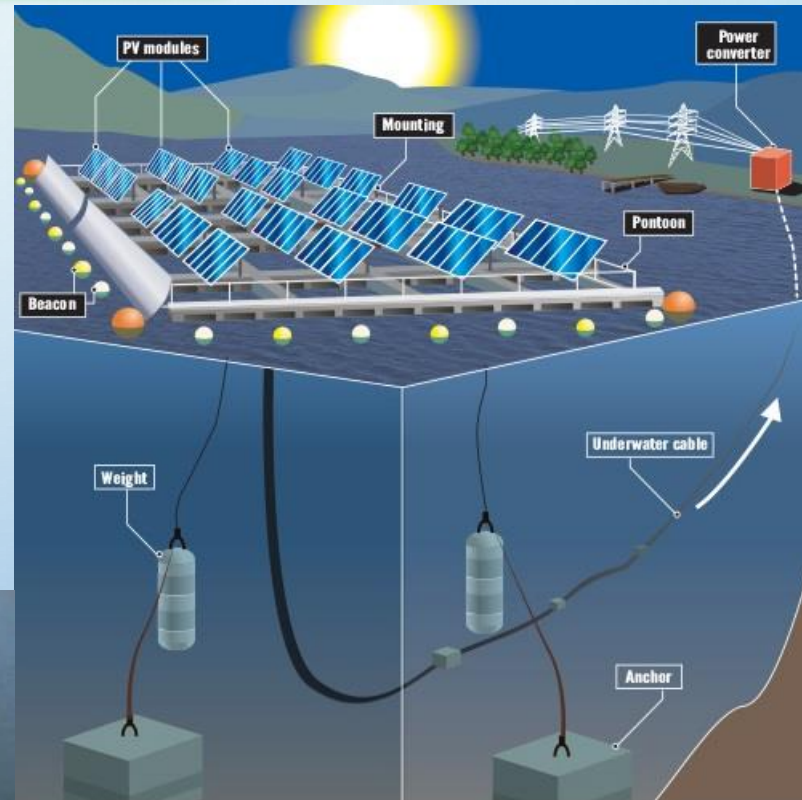

Floating Solar PV Technology

→ design considerations

❑ **Inverters**

- Based on the geometry of the water body and the detailed system design of the floating solar PV, centralized as well as string inverters are used and can be placed either on land or on the floating platform

❑ **DC & AC cables**

- Should have excellent weather proofing characteristics
- Options:
 - ✓ Regular DC or AC cable on the water surface lifted by buoys
 - ✓ Submerged cable in a water proof conduit



Credit: Kyocera TCL Solar LLC



Credit: Ciel et Terre

Floating PV System Installations

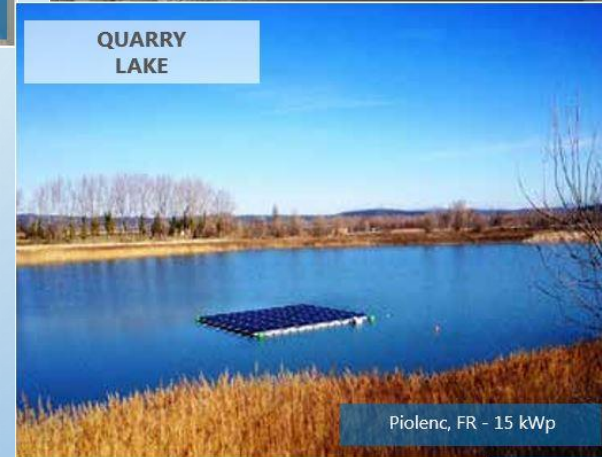

- Industrial water ponds
- Quarry/mine lakes
- Irrigation reservoirs
- Desalinization reservoirs
- Water treatment sites
- Drinking water surfaces
- Aquaculture Farms
- Dams / Canals
- Retention ponds

Growing Trend in Floating Solar PV Installations Worldwide

Global installations of FPV 2007 to 2018

■ # of FPV installed ■ Cumulative # of FPV installed

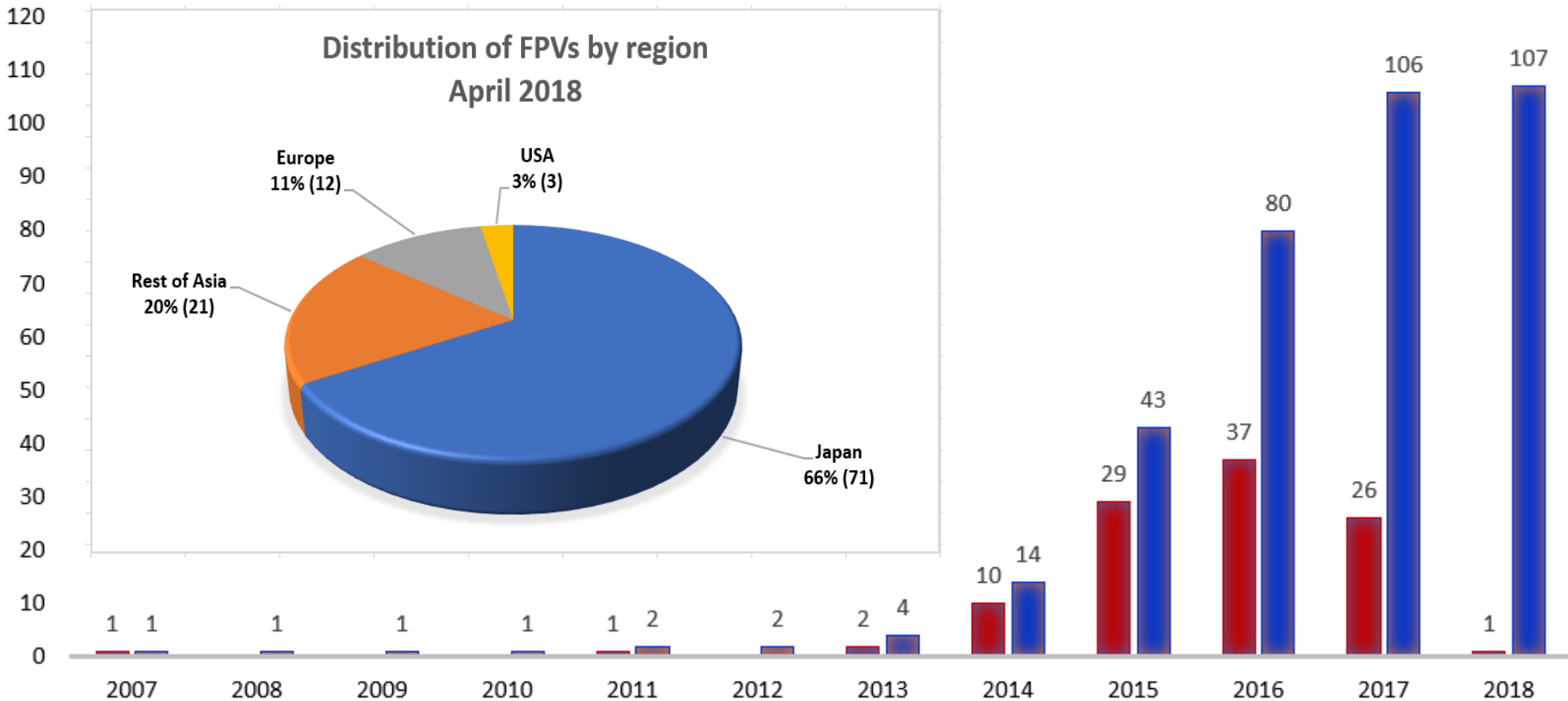

Growing Trend in Floating Solar PV Installations Worldwide

Capacity of installed FPVs, in MW

2007 to 2018

■ Aggregate size (MW)
 ■ Cumulative size (MW)



Floating Solar PV Systems - Example

400 kW floating solar farm in Napa, California

Application: power for winery

Technology/Developer: Floatovoltaic™ solar array by SPG Solar and Thompson Technology Industries, Calif., USA



Research & Development (Korea)

**Installation of Juam Dam
2.4kW Research Equipment**

'09.04

**Installation of
Hapcheon dam 500kW
commercial plant**

'12.10

**Installation of Boryeong
dam 2MW plant**

'16.03

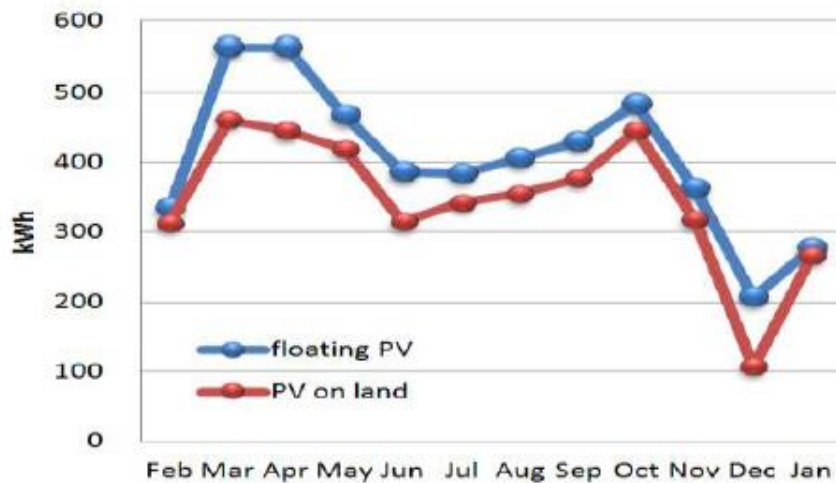

(a) 100kW

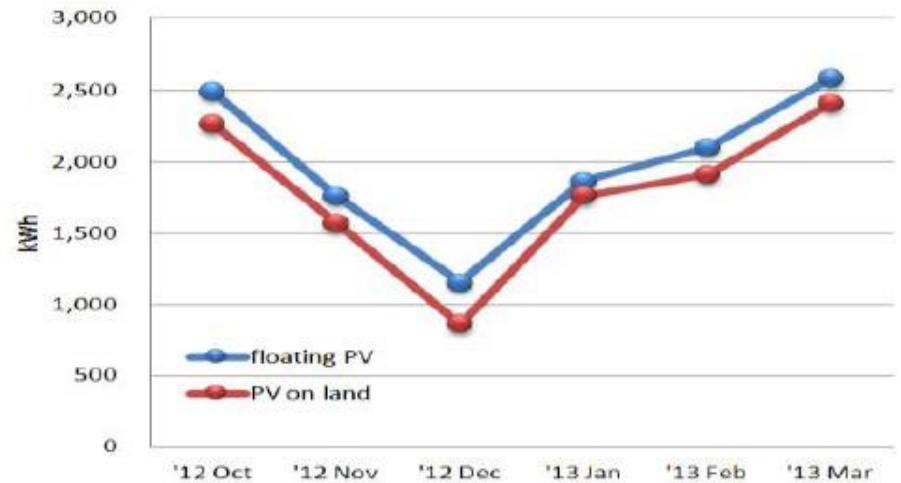

(b) 500kW



**Hapcheon dam 100kW
Demonstration plant
development launched**



**Installation of Sihwa
20kW Research Equipment
for sea**



**Installation of Inje
110kW Research Equipment
for wetland**

Floating PV Systems - Example

200 kW floating solar farm in Sheeplands Farm, Berkshire, UK

Application: renewable energy on-site to power the reservoir's pump for farm irrigation

Technology/Developer: Hydrelia by C&T/Floating Solar UK



Floating PV Systems - Example

6.3 MW floating solar farm in London's Queen Elizabeth II reservoir
Application: power for water treatment works of Thames Water (water provider to London & Thames valley communities)
Technology/Developer: Hydrelia by C&T/Lightsource RE UK





2 MW floating solar project on Boryeong dam reservoir, South Korea
Application: power generation for 700 homes
Technology/Developer: Posmac/K-water



Floating PV Systems - Example

Rendering of the 13.7MW plant on the Yamakura Dam reservoir, Chiba, Japan (2018)
Application: grid-connected power generation to power approximately 4,970 households
Technology/Developer: Kyocera TCL Solar LLC



Floating PV Systems - Example

343 kWp floating solar plant on an irrigation pond, Savona, Italy
Application: power generation (grid-connected)
Technology/Developer: Ciet et Terre



Benefits of Floating Solar PV Systems

Economic

Water surface use vis-à-vis requirement for land



Higher efficiency / higher generation

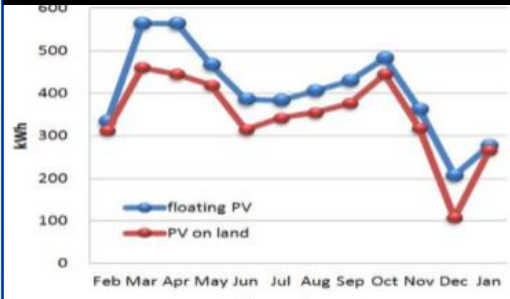

- due to natural cooling effect of water on the panels and electrical equipment

Societal

Land optimization

Water conservation

Clean energy production

Power in remote areas

Climate friendly

Environmental

Forests & farmlands conservation



Water retention





Future Outlook for FPVs

- **Large-scale FPV is gaining ground in the Asian market – with projects above 1 MW picking up since 2014 and in the last 2 years or so, above 10 MW.**
 - Projects with sizes above 100 MW already being rolled out in the next few years
- **Hybrid hydroelectric and FPV systems**
 - Quick survey of countries in Central Asia indicate in-land water resource from HPP reservoirs of at least 3m ha ~ at least 1,500 GW of theoretical potential capacity
 - South/SE Asia (ADB sources): Laos – 1 GW; Bangladesh – 1 GW; Thailand – 6 MW
- **FPVs in marine environment**
- **Storage**